

# Multiple Accumulated Digital Weighing Indicator

MODEL : FS-6100A

FINE INTERKOREA CORP.

# Contents

## 1 Chapter Preface

- 1.1 Introduction
- 1.2 FS-6100A Controller Features
- 1.3 Safty Installation Conditions
- 1.4 External Panel & Installation
- 1.5 Key Pad Function & Presentation.
- 1.6 Screen Configuration & Features

## 2 Chapter Weighing System

- 2.1 Definition
- 2.2 The Configuration of Weighing Part
- 2.3 The Configuration of Relay Signal Procedure
- 2.4 The Flow Chart for Relay Time Signal
- 2.5 FS-6100A Real Side Function

## 3 Chapter Operating

- 3.1 General Operating
  - 3.1.1 Stable Loadcell
  - 3.1.2 No 1 Keypad + Main Power ON
  - 3.1.3 Main Power
  - 3.1.4 ON/OFF
  - 3.1.5 START
  - 3.1.6 STOP
  - 3.1.7 COPY
  
- 3.2 Basic Screen Operating
  - 3.2.1 ZERO
  - 3.2.2 FORMULA
  - 3.2.3 EDIT
  - 3.2.4 MENU

### 3.3 Menu Selection Screen

3.3.1 Basic Screen

3.3.2 Formula Edit Screen

3.3.3 Batch Report Screen

3.3.4 Formula Report Screen

3.3.5 Total Report Screen

3.3.6 Time Set Screen

## 4 Chapter System Setting

4.1 System Setting For the user

4.2.1 Decimal Point

4.2.2 Set Unit

4.2.3 Weight Back Up

4.2.4 Decision Delay Time

4.2.5 Signal Duration Time

4.2.6 Empty Range

## 5. Chapter Calibration

\* Quick Operating Manuals \*

# 1. CHAPTER PREFACE

## 1-1. Introduction.

Thank you very much for your purchasing FINE Digital Weighing Indicator of **FS-6100A**.

This Instruction Manual will lead you to use **FS-6100A** with Top reliability, High speed, High accuracy for your Production Lines.

FS-6100A Controller is a Weighing Equipment which can produce the Products the user want by the weighing of a regular RATE for a various law Materials.

FS-6100A Weighing System is to charge and discharge Law-Materials with 2STEP Gate of BULK and DRIB Signal based on HIGH & LOW LIMIT Management as the user want.

Also The product Mixture RATE can be set by FORMULA Format of Each BIN(Basic 40ea) as the user set up Before working.

Also The user easily can produce the products by calling the FORMULA of Each BIN according to a various Law-Materials.

The mixture rate of Law Materials can be controlled by FORMULA(Basic 40ea Memory) built in **FS-6100A** and it work easily by calling the Formula No. Also the user can use FS-6100A for more precise weighing by High, Low Range setting.

**Also** an additional option will make Modern Industry demand equipment that both versatile And available to easily connect to other devices

### REMARK

- Specification subject to change for improvement without prior notice.

## 1-2. FS-6100A Controller Features

- a. This Automatic Accumulated weighing Controller was used to control a various Kinds of materials(basic 8kinds of materials : 8BIN) as the user set up.

### **The Main Application**

- Automatic Accumulated Weighing System.
  - Various Materials Auto Mixture System.
- b. Each BIN can output each Material by the below 2step system
- 1step(BULK) : TARGET - DRIB
  - 2step(DRIB) : TARGET - FALL
  - As EACH BIN will be controlled by these 2step Control system Every BIN  
A correct material weight can output from BIN quickly as the user set up
- c. Printing function(option)
- Centronics Parallel I/F
  - Available to record and print the actual weight of Each BIN
  - Available to count the TOTAL for Each BIN
  - Print Format was included with DATE,FINISH TIME,Each Bin Weight.
- d. Available to set up the range value as the user by Absolute value system
- e. Built In BACK-UP of all data while power off
- f. Function for Auto-Calibrations of ZERO and SPAN.
- g. Auto Zero Tracking Function.
- h. Built in compensation Circuit for Temperatuer variations and Noise
- i. Function to memory EACH Target weight,Drib,Fall,Over and Underweight.
- j. Available to call the Mixture Rate of 40kinds of Items the user set up from CPU.
- k. Easy to operate the controller by Numerial Key and Direction Key.
- l. HELP service for each operating instruction.
- m. Graphical LCD DISPLAY and setting a various ITEM informations.
- Formula Edit Display for New Formula INPUT.
  - Level Bar Display for a weighing processing.
  - Histogram Display for the final data processed
  - Formula Histogram to check the processing easily per Formula
  - Total Histogram Display for total processing
- n. External equipment control functions(option)
- RS-232C,RS-433/485,Current Loop,BCD input & output.

## 1-3. Safty Installation Conditions.

Please keep the following Safty Conditions certainly for Top reliability, High speed,  
High accuracy for your Production Lines.

### ◆ EARTH

To avoid an electric Error such as a noises in your production line

It should be earthed before installation certainly.

Specially If Welding the weighing Part(Hopper Scale Part)

Surely It should be separated to the lines between a Loadcell and FS-6100A

### ◆ SAFTY Factory Conditions

- Don't use it around a explosive gas and an inflammable dust environments

- Please Install FS-6100A not closed to the main power supplyer and

Inductivity Magnetic Voltage Equipment

### ◆ POWER

Use the power under AC 110/240V 50/60HZ  $\pm 10\%$  (Free Voltage).

### ◆ Temperature Conditions.

- OPERATING TEMPERTURE :  $5^{\circ}\text{C} \sim +35^{\circ}\text{C}$  (  $-41^{\circ}\text{F} \sim 95^{\circ}\text{F}$  )

- Please use FS-6100A around  $\pm 2^{\circ}\text{C}$  Range of Temperature Variation

### ◆ Installation Load cell

- Available to use the same Load cell of 8pcs (  $300\Omega$  Standard )

- In case of using 6LINE Type Load cell,

Please do OFF of Dip-Switch(No 1 and No 2 ) in Analog Board of FS-6100A

( Basically it was set by 4LINE Type Loadcell before you will use)

- A ground should be installed horizontally

- Specially If Welding the weighing Part(Hopper Scale Part)

Surely It should be separated to the line between a Loadcell and FS-6100A.

# 1-4. External Panel & Installation

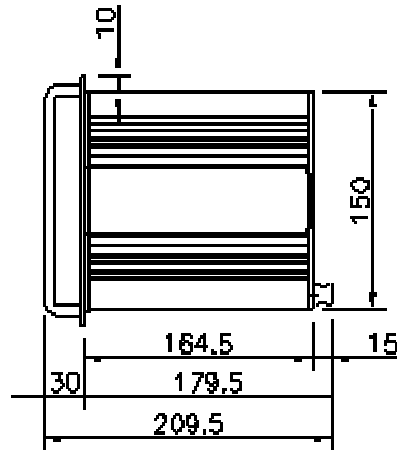
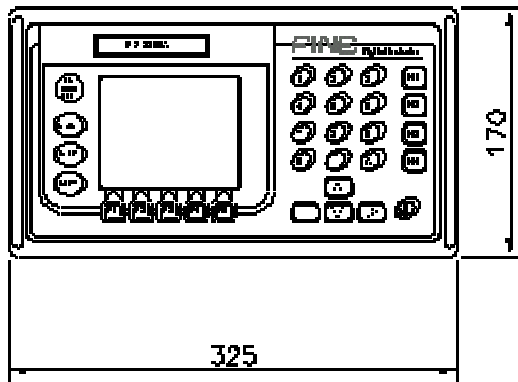
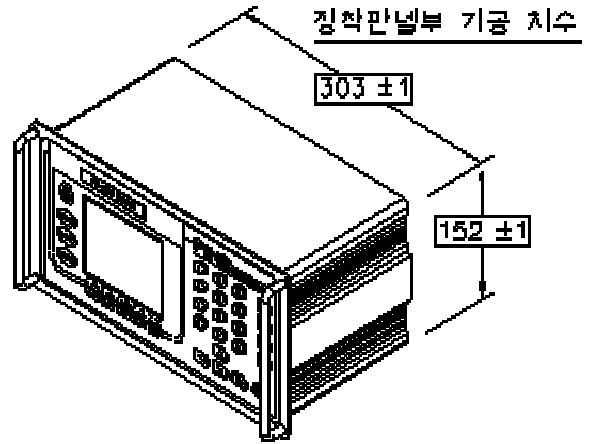
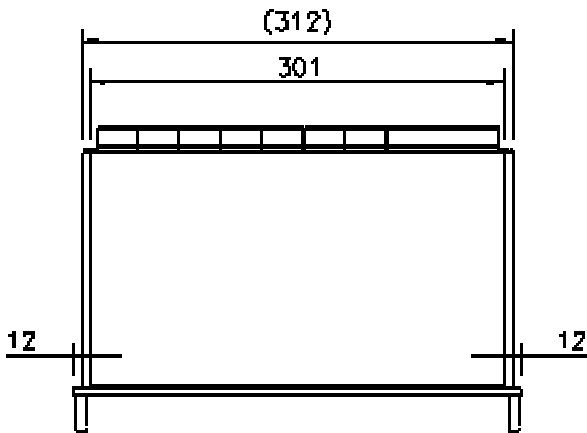

## (1) Installation

Pls cut the Panel with 303mm(L) x 152mm(W) to install FS-6100A  
 Then, it should be Back Space Room with 230mm.  
 After removing 2pcs of Guide Installed on sides of Main Body,  
 Then, please push the Main Body into Panel and insert Guides again.

## (2) CASE Size Installed.

( L : 303mm ± 1mm )

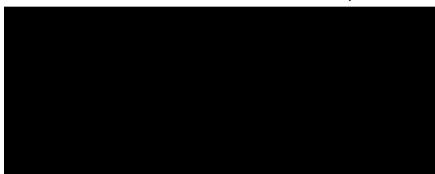

( W : 152mm ± 1mm )

## (3) Installation Position

A suitable Installation Height is around 1600mm which the worker can see easily

## 1-5. Key Pad Function & Presentation.

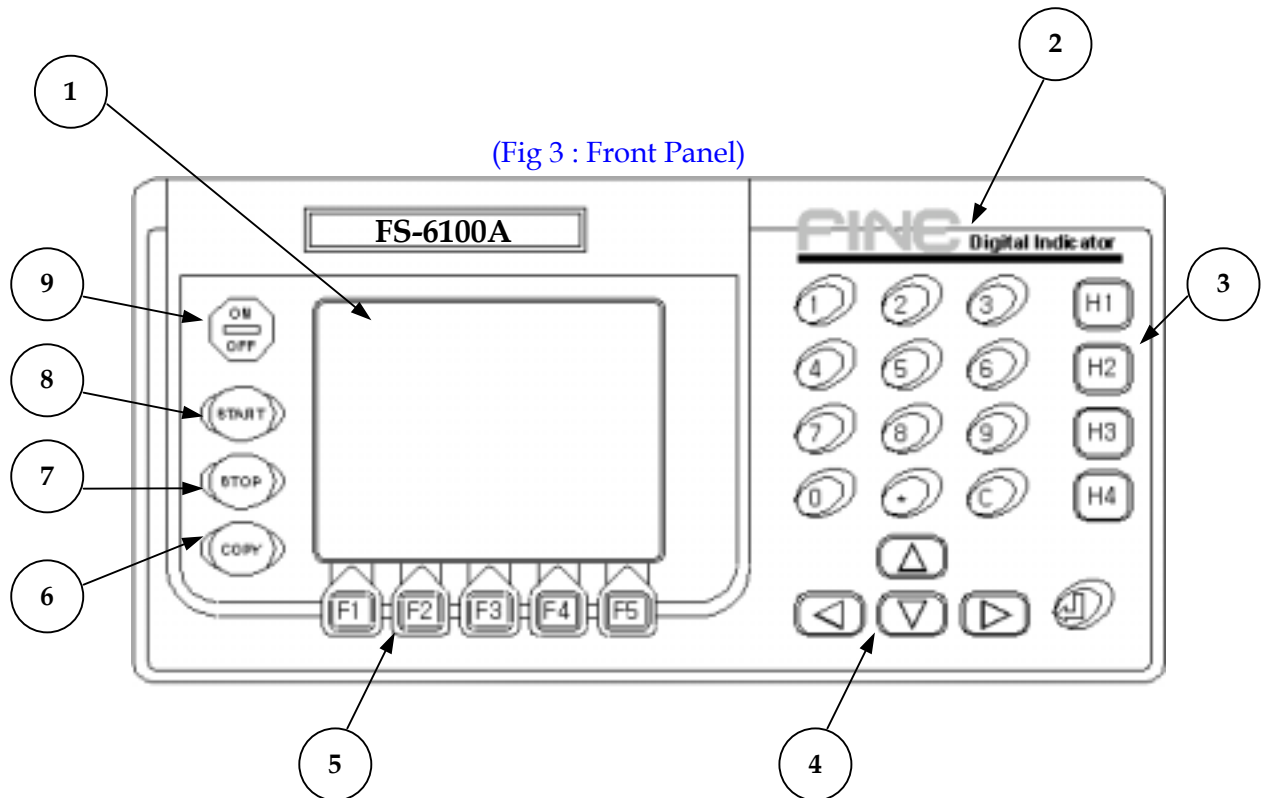

- ① 320 x 240 DOT Graphical LCD Screen.
- ② Numerical Key : Inputting Setting Value and Selecting Manu.
- ③ HOT key : It Can directly go to the Main Screen which the worker mainly use .
- ④ Direction Key : Movement by Cursor or Inputting Preset Value
- ⑤ Funciton Key : F1 ~ F5 Key
- ⑥ **COPY** Key : It Can print the screen Contents.
- ⑦ **STOP** Key : It Can Stop to Work Temporarily or to Canceal completely.
- ⑧ **START** Key : It Can Start to Work in Manual.
- ⑨ POWER (**ON/OFF**) : It does not work in running status.



## 1-6. Screen Configuration & Features

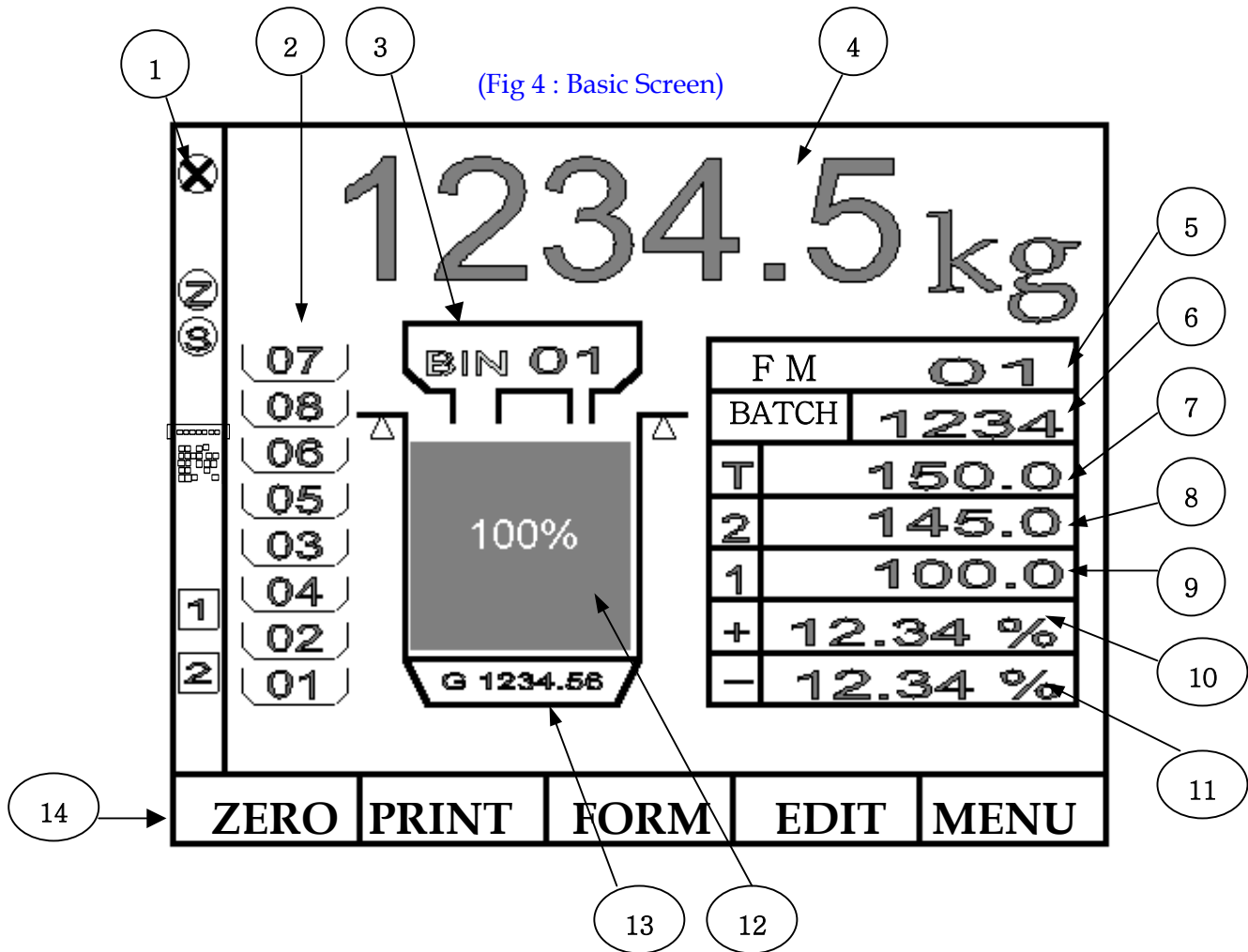

(1) Icon : It display FS-6100A Running Satus.

- RUN

- ON Running : It means to run the weighing work by START Signal.

- OFF Running : It means to FINISH BIN Work or to STOP the weighing work by STOP Signal.

- ZERO

: It means that the weighing PART was Empty.

- STEADY

: It means that the weight on a weighing part was steady

- BULK

: It means that BULK Gate is running.

- DRIB

: It means that DRIB Gate is running.

**(2) BIN SELECTION**

: It displays the BIN Processing Sequence and Classification.

Or It displays on Reverse if it is running or already FINISHED.

**(3) BIN DISPLAY**

: It displays the waiting to run or the BIN NO to run.

**(4) WEIGHT DISPLAY**

: It displays the weight on a weighing part with NET or GROSS weight.

- Run : It displays the NET WEIGHT of BIN in running.
- FINISH : It displays the GROSS WEIGHT in a weighing part.

**(5) FORMULA DISPLAY**

: It displays FORMULA NO which will start to weigh.

- Possible to set from 01 to 40 NO.
- If it change FORMULA NO,  
Please select FORMULA under the screen >>> Input the Target NO  
>>> Input ENTER key
- BUT,It can not change in running

**(6) BATCH DISPLAY**

: It display TOTAL BATCH WORKED Number now.

**(7) " T " DISPLAY**

: It displays TARGET WEIGHT.

**(8) 2 DISPLAY(TARGET - FALL)**

: It displays the weight which 2STEP(DRIB) Gate Closed.

**(9) 1 DISPLAY(TARGET - DRIB)**

: It displays the weight which 1STEP(BULK) Gate Closed.

**(10) " + " DISPLAY**

: It displays HIGH Manage Percentage of TARGET WEIGHT.

\* It displays on Reverse with HIGH SIGNAL if it was excessive to HIGH Manage Range after 2TH STEP Gate SIGNAL closed.

**(11) “ - “ DISPLAY**

: It displays LOW Manage Percentage of TARGET WEIGHT.

\* It displays on Reverse with HIGH SIGNAL if it was excessive to LOW Manage Range after 2TH STEP Gate SIGNAL closed.

\* BUT,It can not manage HIGH and LOW in case of Setting “0” to HIGH,LOW Setting.

**(12) WEIGHT LEVEL DISPLAY**

- It display with Percentage Rate or displays with Vertical Level Graphical for a current weight against TARGET WEIGHT.
- In Case of BIN running,It displays with Rate for BIN TARGET WEIGHT.
- In Case of BIN waiting,It dispalyes the Rate of Gross Weight up to now After finishing a previous BIN

**(13) GROSS WEIGHT DISPLAY**

: It always displays GROSS WEIGHT on a weighing Part.

**(14) FUNCTION SELECTION DISPLAY**

: It displays the FUNCTION Contents of F1,F2,F3,F4,F5

# CHAPTER 2. WEIGHING SYSTEM

## 2-1. Definition

### (1) BIN :

It means a structure which can stock each materials,FS-6100A can use 8BIN basically.

Also the Abbreviation of BIN is "B" on the screen.

### (2) FORMULA

It means The Parameter point value which preset the Material Weight for Each Product Weight as the user asked on Each Number.

These Formula can be preset until 40Ea( No 1 ~ No 4).

Also the Abbreviation of Formula is "FM" on the screen.

**R.F) Formula will be preset without a regular Sequence and can be preset with double.**

### (3) TARGET

It mean the final weight the user want.

### (4) DRIB

It can preset the weight to input the material by 2Step Gate for a precise weight.

### (5) FALL

It can preset the weight to input a Hopper Scale after closing the material Gate.

### (6) 1<sup>st</sup> STEP Gate

It means 90% or BULK and means the largest Materials of 2 Gates.

It stopped the discharger for the weight reduced DRIB from TARGET.

**1<sup>st</sup> Step = TARGET - DRIB.**

### (7) 2<sup>nd</sup> STEP Gate

It means 100% or DRIB and also the samller Materials of 2 Gates.

It stpped the discharger for the weight reduced FALL from TARGET.

**2<sup>nd</sup> Step = TARGET - FALL.**

## 2-2. The Configuration of Weighing Part

It will be discharged to the weighing part by 2STEP Gate according to the Sequence of Each Formula the user set up.

Also It work the next BIN after a BIN Finishing as the user set up

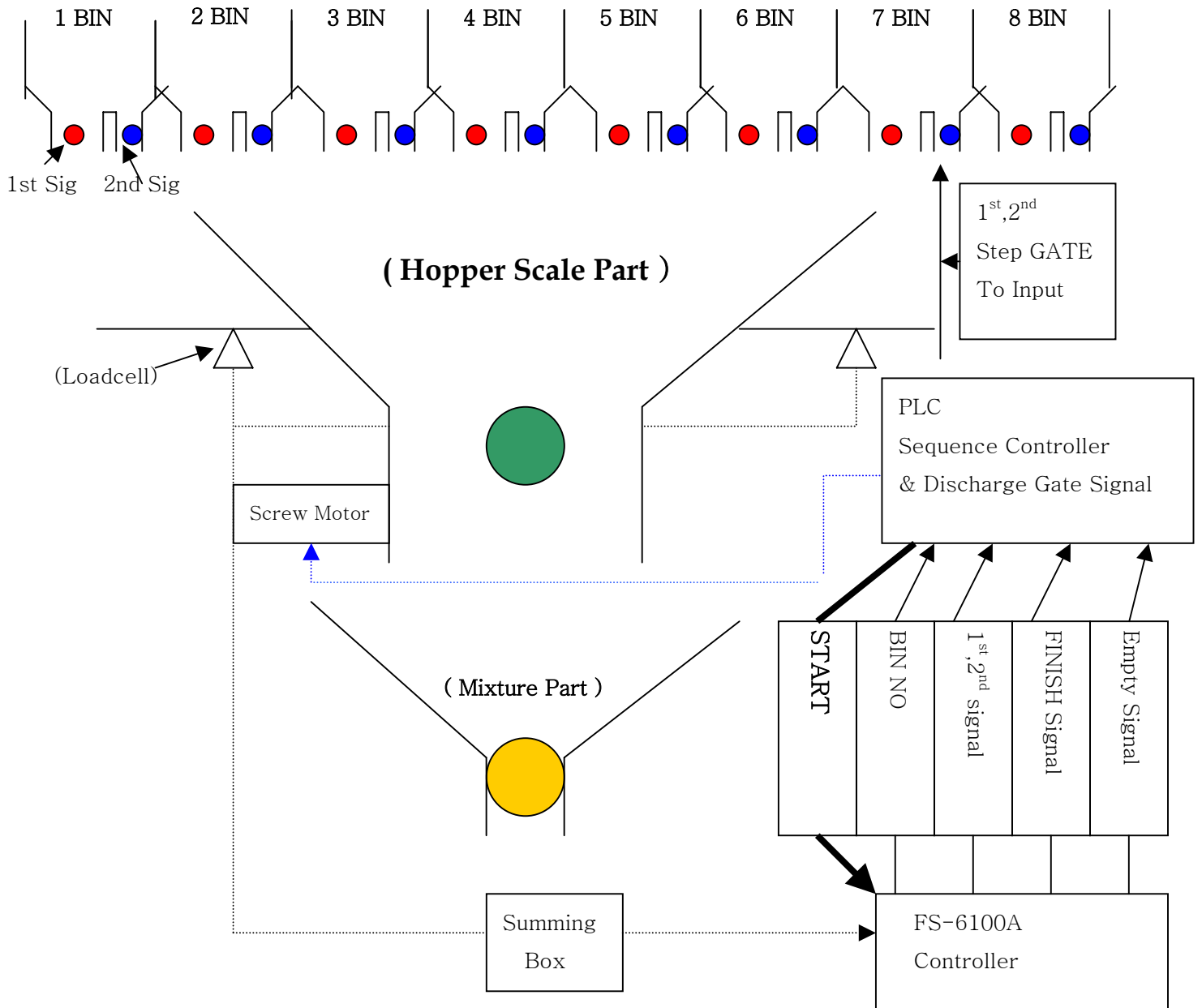

## 2-3. The Configuration of Relay Signal Procedure

- (1) **START**: It is the Signal to start the weighing (**PLC >>>> FS-6100A**)
- (2) **BIN NO** : **BIN NO** of Material which will be weighed **>>>> PLC**
- (3) **1,2STEP** : The **OPEN/CLOSE** of Gate **>>>> PLC**
- (4) **BIN FINISH** : **Finish Signal** of BIN Material **>>>> PLC**.
- (5) **BATCH FINISH** : **A Final Signal** after finishing the last BIN **>>>> PLC**.
- (6) **EMPTY WEIGHT** : **the Signal** of Case which a weighing Material was under Empty on the Hopper Scale **>>>> PLC**.
- (7) **HIGH** : **HIGH Relay** will be sent when the weighed result was excessive to the HIGH LIMIT of TARGET Weight.
- (8) **LOW** : **LOW Relay** will be sent when the weighed result was excessive to the LOW LIMIT of TARGET Weight.
- (9) **RUN** : **RUN Signal** run from the BATCH START to BATCH FINISH by START Signal. Even if it stopped by STOP Signal, RUN Signal continues to work  
But, **RUN Signal** can be removed by BATCH FINISH Signal and RESET Signal ONLY
- (10) **STOP**: **STOP Signal** is used to stop the weighing WORK Temporarily.  
It don't need for a normal Work.
- (11) **RESET**: **RESET Signal** is used to Cancel the Work.
- (12) **Compulsory START** : Even if a final weight was Excessive to HIGH Or LOW Limit Manage ,then if the user want to continue to run the work,  
The user can continue to work by pushing START Key .

## 2-4 The flow chart for Relay Time Signal

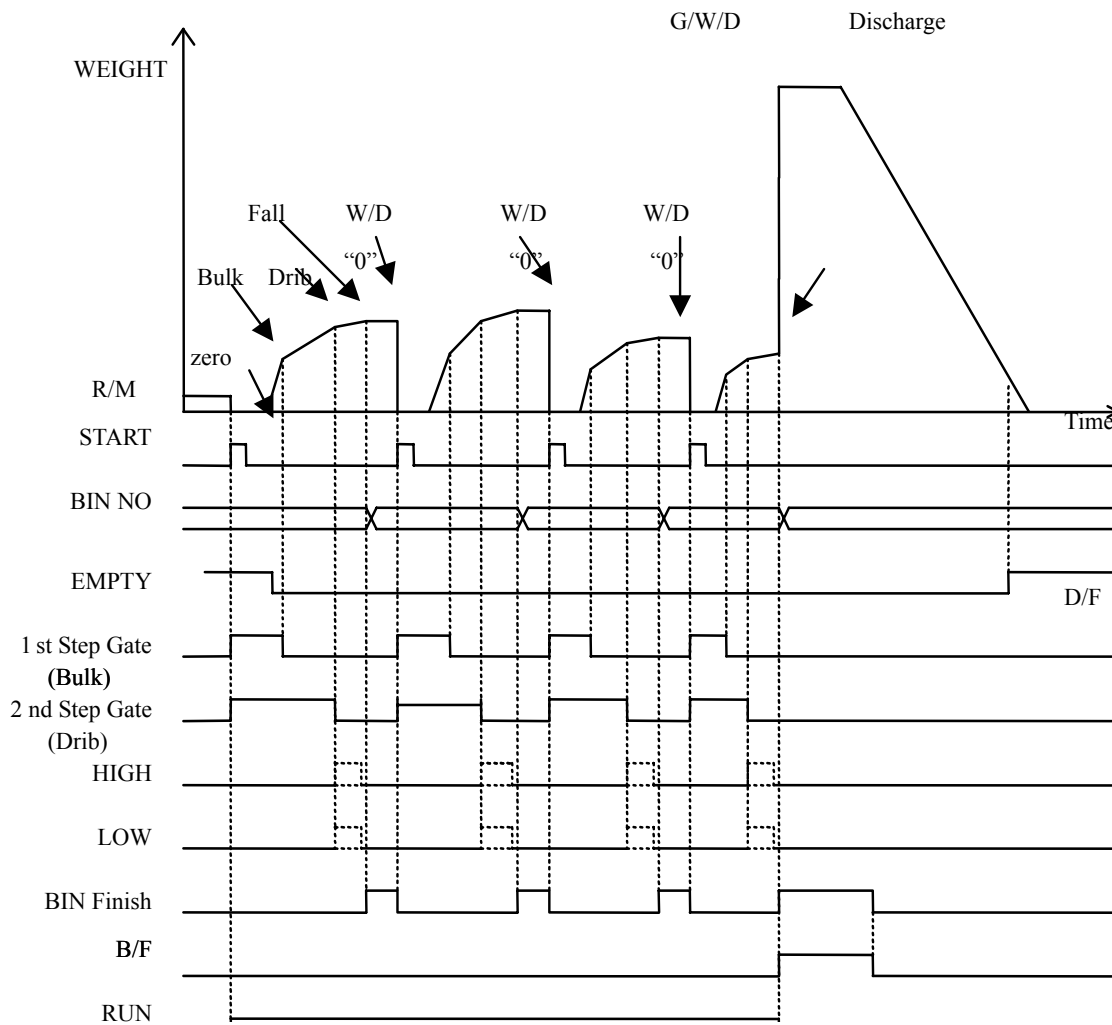

### \* Abbreviation \*

- G/W/D : Gross Weight Display
- W/D : Weight Display.
- R/M : Remained Materials
- D/F : Discharge Finish
- OTP : Out of Tolerance Positive/OTN :Out of Tolerance Negative

## 2-5 FS-6100A Real Side Function

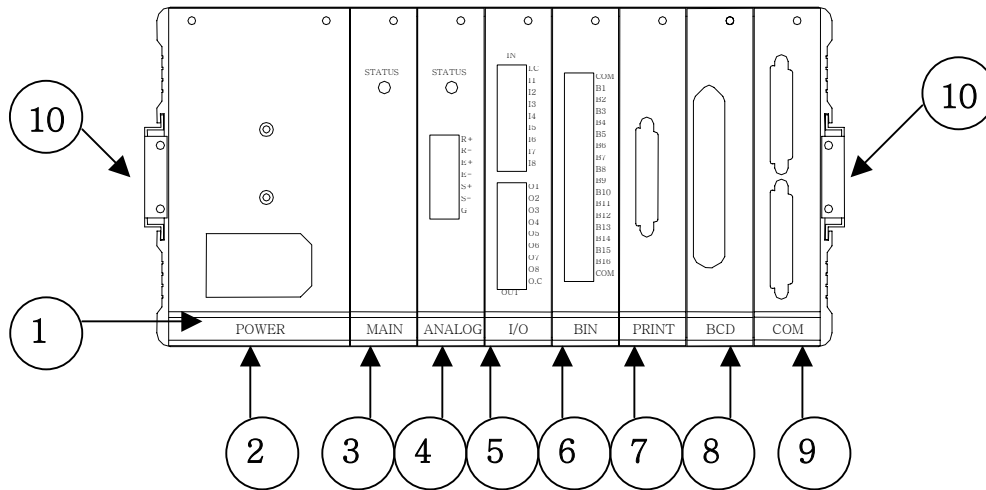

- ① Power Switch : Fuse + Plug
- ② Power Board : AC100V ~ 240V 50Hz/60Hz
- ③ Main Board : CUP,Memory,Program Rom
- ④ Analog Board : Analog Signal of Loadcell >>>>> Digital Signal Conversion

In case of 6pcs Loadcell : Dip-switch(No 1,2) = OFF.

R+ = Return Line of E+

R- = Return Line of E- ( Dip-switch(No 1,2)=ON for No use)

E+ = Power Line of +5V

E- = Power Line of 0V

S+ = + Signal Line

S- = - Signal Line

- ⑤ I/O Board : Each 8pcs for External Control Input and Output Mode.
  - Input Signal must be connected by No Voltage of over 50Msec.
  - Output Signal must be connected by No Voltage of under 250V/0.2A



⑥ BIN Board : Board to output the relay until Max,16BIN.

INPUT				OUTPUT			
1	STOP	5	ZERO	1	EMPTY	5	1 <sup>st</sup> Gate
2	START	6	NO DEFINE	2	RUNNING	6	2 <sup>nd</sup> Gate
3	RESET	7	NO DEFINE	3	BIN FINISH	7	OTP
4	Compulsory START	8	NO DEFINE	4	BATCH FINISH	8	OTN

⑦ PRINT Board : Can all data to the printer by Centronics Parallel.

⑧ BCD Board : BCD I/F for total data

⑨ COM Board : Serial I/F for RS-232C,RS422/485,Current

⑩ Fixed Braket : Can fix this control to the panel.

**\* Abbreviation \***

- OTP : Out of Tolerance Positive
- OTN : Out of Tolerance Negative

# CHAPTER 3. OPERATING

## 3-1. General Operating

### 3-1-1. STABLE LOAD CELL

\* The output power of load cell which was used as a weight sensor is  $1\text{mV/V} \sim 3\text{mV/V}$

▣ The output voltage of load cell is not absolute value but relative value.

Ex) if Max weight was loaded to 10kg & 10ton load cell of  $3\text{mV/V}$  output,

The Output Voltage is the same as  $3\text{mV/V}$

Load cell Connector

\* Please connect the indicator connector with the wire of load cell According to the color.

\* Possible to connect the load cell of the same kind in parallel up to 8pcs.( Max  $300\Omega$  )



	1(EXC+)	2(EXC-)	3(SIG+)	4(SIG-)	5(SHLED)	비고
FINE INDICATOR'S WIRE COLOR	RED	WHITE	GREEN	BLUE	SHIELD	
BONGSHIN, CAS, TMI, AND	RED	WHITE	GREEN	BLUE	SHIELD	
DAESUNG LOAD CELL	RED	BLACK	WHITE	GREEN	SHIELD	
JUNGSAN	RED	WHITE	GREEN	BLACK	SHIELD	
DAISOCELL	RED	BLUE	GREEN	WHITE	BLACK	
DANA	RED	WHITE	GREEN	BLUE	SHIELD	
BLH	GREEN	BLACK	WHITE	RED	YELLOW	
INTERFACE	RED	BLACK	GREEN	WHITE	SHIELD	
KYOWA	RED	BLACK	GREEN	WHITE	SHLED	
P.T.	RED	BLACK	GREEN	WHITE	SHIELD	
SHOWA	RED	BLUE	WHITE	BLACK	SHIELD	
SHINKOH	RED	BLACK	GREEN	WHITE	SHIELD	
TML	RED	BLACK	WHITE	GREEN	SHIELD	
TEAC	RED	BLUE	WHITE	BLACK	YELLOW	
HUNTLEIGH	GREEN	BLACK	RED	WHITE	SHIELD	

### 3-1-2. No 1 of Keypad + Main Power On

Please turn "ON" of Power Switch while pressing No 1 of Keypad.  
Then You will find out the following screen

#### MENU SELECT

1. A/D CONVERTER
2. KEY BOARD TEST
3. MEMORY INITIAL
4. RAM TEST
5. AUTO SET UP
6. L/C CALIBRATION

Then,you must press the above NO 6(L/C Calibration : Loadcell Calibration)

You will find out CALIBRATION MODE.

Please follow up CALIBRATION According to **CHAPTER 5(CALIBRATION)**

### 3-1-3. Main Power

Generally the user must use FS-6100A after 10minute for WARMMING TIME after power ON.Also please don`t do POWER ON/OFF continuously.

### 3-1-4.ON/OFF

Please use Always POWER ON/OFF on the front Panel

And pleaes POWER OFF for connecting with A loadcell or replace the BOARD.

### 3-1-5.START

START KEY on the front Panel was used for TESTING OR Manual operating.

**\* Pushing START KEY Button without            ICON on the front Screen.\***

Generally the first screen displays " 0 "

If the first screen displays "123 or 111" insteady of "0",

Because the weighing part has some remained Materials,

Please push START Key after Finishing to discharge.

(Refer)

If the First START Signal work Until Max. Weighing Range 10%,  
Then, ZERO Setting automatically works.

So, In case of A general START running,

- (  ICON work,
- 1<sup>st</sup> STEP ,2<sup>nd</sup> STEP Gate work
- Gate Signal work at the same time.

In case of BIN, TARGET, BULK, DRIB, FALL NON-Setting,

(  ICON does not work also GATE Signal does not work that is START Signal does not work.

And START Signal will be available until BIN will be finished.

Also please Push START Key button for the next BIN Weighing.

**\* Pushing START KEY Button on ICON STOP on the front Screen.\***

The reason to stop ICON have 2 type case.

The First Case

- Generally the first screen displays “ 0 “  
So, it means A normal waiting status for the next BIN weighing after FINISH to weigh.

The Second Case

- It is Case that The weighing Running was stopped by STOP KEY or Electronic Spark.
- Because this Case was stopped on Compulsory, RE-START Key can continue to work after Stopping.
- That is, all weighing work will be started from a current weight.
- So, because FS-6100A is always back up doing for a weighing Memory  
Even though the weighing work was stopped by STOP or Electronic Spark,  
Then, the continuous work will be possible by RE-START Key.
- If it want to cancel a stopped work completely,  
Please push STOP Button or send RE-SET Signal from External Controller.

### 3-1-6. STOP

Please don't use this STOP Key in Not Normal Running only except of Normal Running.

In Case of STOP

1<sup>st</sup> STEP,2<sup>nd</sup> STEP Gate Signal was Closed and (  ) ICON does not work

Then,if it push START Key for Re-Work,the weight will work continuously after a current weight

BUT,In Case of removing all Work,

Then,if it push STOP Key again, " RESET ALL" display on the Screen then If selecting NO 1 on the screen,all Weighing Work will be completely canceled.

### 3-1-7. COPY

It can print all contents on the screen like Hard Copyl.

It helps the user to record for the next weighing work or for a Efficiency.

Also any printer can print them by Centronics Parallel system

### 3.2 Basic Screen Operating.

(Fig 7 : Basic Screen)

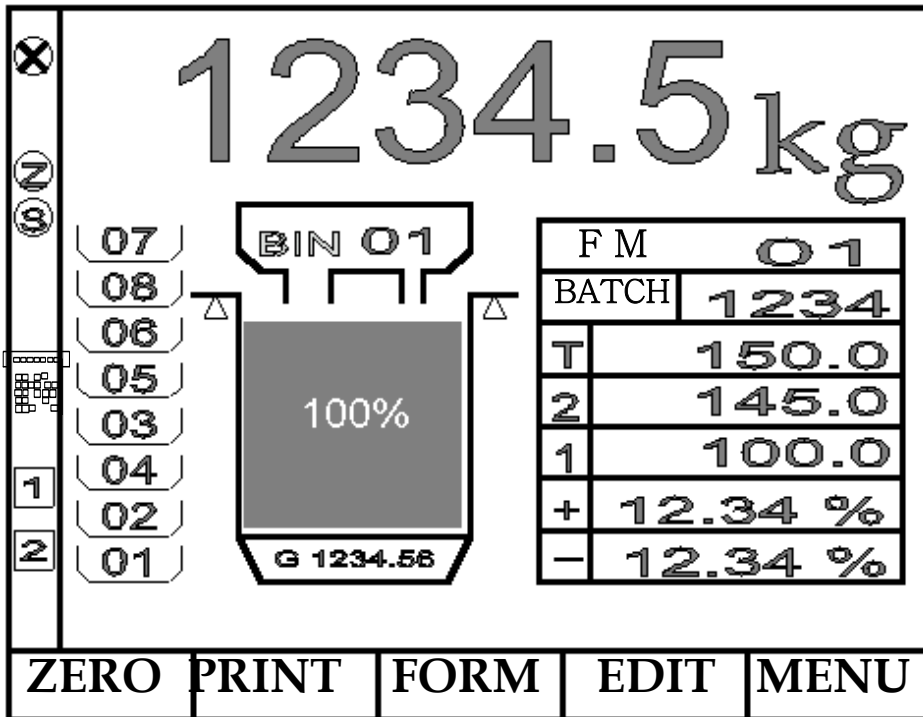

This Basic Screen is FS-6100A Basic Screen and can check how much a weighing work is processing According to EACH BIN.

#### 3-2-1. ZERO

Generally this Key is used to make the weighing part with ZERO like a General Scale. So,FS-6100A can permit the ZERO Range till 10% of Max.Capacity.

(Refer)

**ZERO does not work in running work.**

Also Because the first Start weighing will be ZERO automatically, It will be not necessary to use ZERO KEY.

#### 3-2-2. FORMULA.

This Formula can memory the mixture Rate of a various Law Materials. So,the user can work easily after calling this Formula No which already set up

Also if it input NEW BIN NO and push ENTER Key after FORMULA Key, It automatically will be set like the previous BIN NO Set Contents.

(Refer)

**FORMULA EDIT does not work in running work.**

### 3-2-3. EDIT

It can EDIT all Contents in FORMULA.

Pushing EDIT Key converts to the EDITTING Screen automatically.

Then,Despite of converting to the EDITTING Screen,it will not effect on the weighing work.

Generally the user can use EDIT Key to modify the existed setting contents.

(Refer)

- Currently a weighing FORMULA does not edit
- Despite of in weighing another Formula No.  
Another Formula Edit is Available.

### 3-2-4. MENU

Pushing MENU Key can help a various informations screen.

### 3.3 Menu Selection Screen

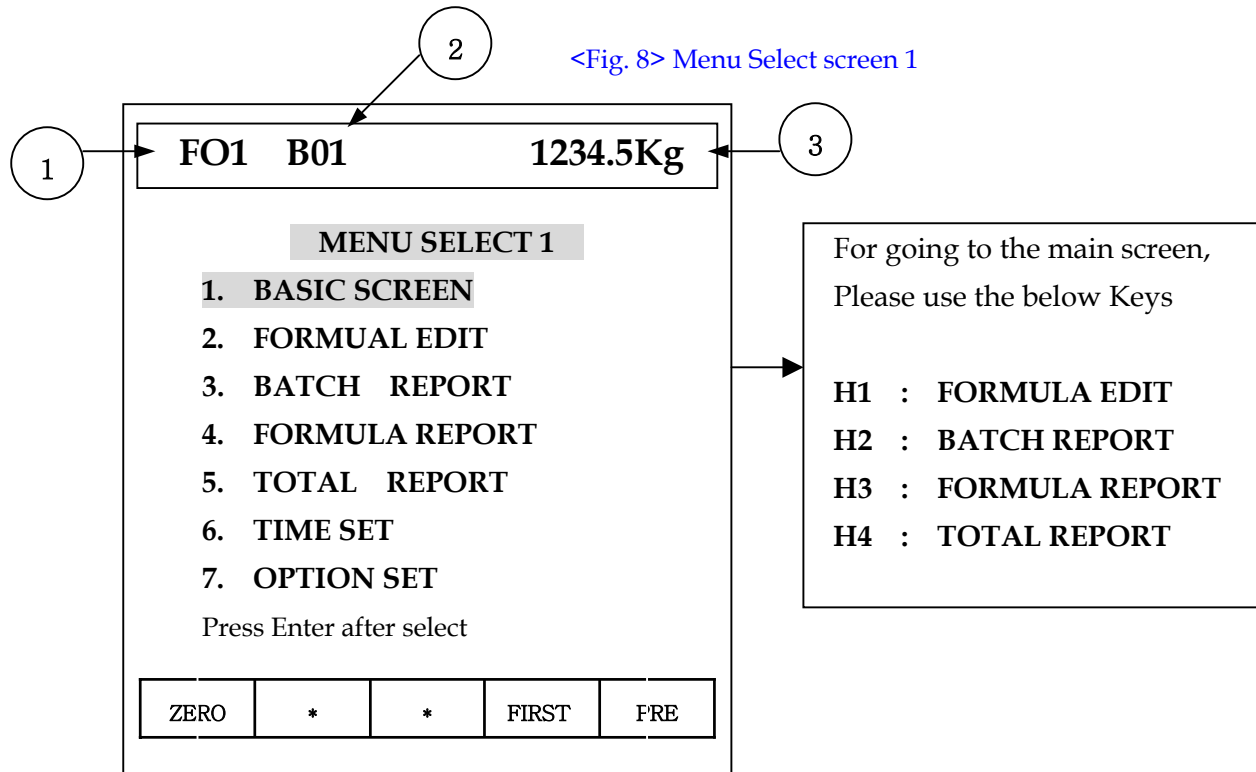

- (1) It displays FORMULA Number in Running.
- (2) It displays BIN Number in Running
- (3) It displays WEIGHT in weighing work.

If it want to convert another screen, then please do that by Cursor Key or Inputting Number .

#### 3-3-1. BASIC SCREEN

It converts to BASIC SCREEN (Fig 6)



### 3-3-2. FORMULA EDIT SCREEN.

The use easily can edit all contents comparing to another BIN setting contents in ONE Screen.

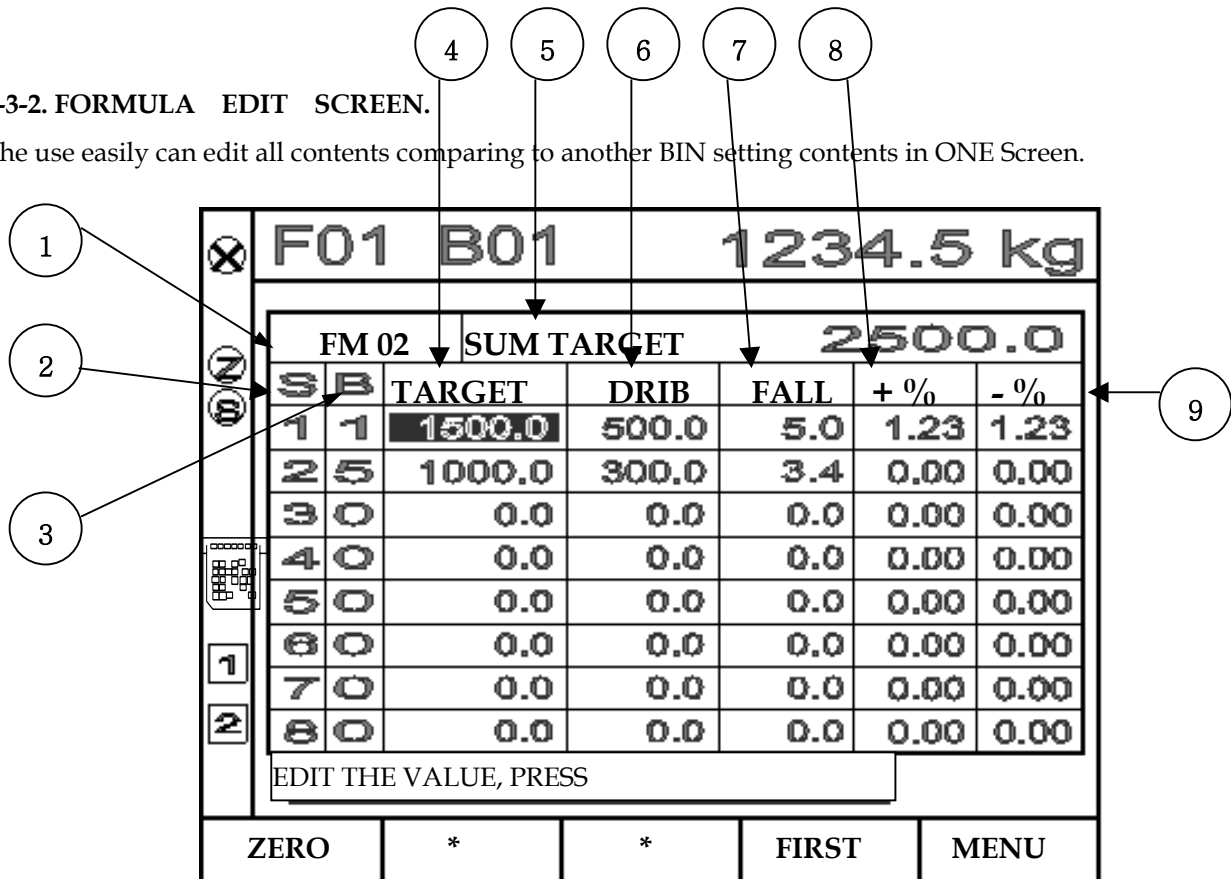

(1) FORMULA : It can Edit Another BIN Contents while ONE-Running.

So,even though BIN Number 1 is running now,then it can edit BIN NO 2 contents.

(2) S : It means the weighing Sequence.

(3) B : It mennis BIN NO which the user try to use.

(4) TARGET : BIN TARGET WEIGHT

(5) SUM TARGET : Total Accumulated Weight.

(6) DRIB : It means 2<sup>nd</sup> STEP Gate and the weight for a precise weight.

(7) FALL : The weight which supply to the weighing part after 1<sup>st</sup> Gate & 2<sup>nd</sup> Gate was Closed.

(8) + % : It means the permitting range(%) of the Overweight excessive to TARGET

(9) - % : It means the permitting range(%) of the Underweight excessive to TARGET

Generally FS-6100A Can accumulate and work the next BIN after checking the weight in the permitting Tolerance after closing the 1<sup>st</sup> STEP and 2<sup>ND</sup> STEP Gate.

Then,if It check HIGH,LOW Signal this screen dispalyes on reverse.

So,at this time if the weight will be Normal work by adjustment in Manual,

The weight will be accumulated normally and can do the next work.

Also if it continue to work without Weight Compensation,

It can work by compulsory START Key

BUT,This Compulsory START Key is only a External Input Signal.

(REFER)

“ O % ” Setting of HIGH & LOW can NOT check the weight of HIGH & LOW Tolerance



**3-3-4. FORMULA REPORT SCREEN.**

It displays BATCH WORK NO, TOTAL Accumulated Weight, Accumulated for Each BIN, The first TIME and The last TIME to work.

(Picture 11 : FORMULA REPORT SCREEN)

F01 B01		0.0 kg	
[REDACTED]			
(N) (S) [KEYBOARD]	FM 02	2500.0	
	1	3000.0	BATCH
	2	0.0	2
	3	0.0	START
	4	0.0	2002-05-05
	5	2000.0	12:34:56
	6	0.0	FINISH
	7	0.0	2002-05-05
	8	0.0	12:45:33
[REDACTED]			
ZERO	PRINT	DELETE	FIRST MENU

1

2

**DELELT** : It CAN delete all HISTOGRAM For Each BIN.

**(2)** : Worked Batch Number

**(3) PRINT** : It can print Total Accumulated Weight according to Each Formula No

### 3-3-5. TOTAL REPORT SCREEN

It Displays BATCH Frequence No of All Formula,Total Accumulated Weight,Accumulated Weight of EACH BIN,The first and Last Time of Weighing.

(Picture 12 : TOTAL REPORT SCREEN)

<b>F01 B01</b>		<b>0.0 kg</b>	
████████████████████			
	<b>TOTAL</b>	<b>41003000.0</b>	
	<b>BATCH</b>	<b>123456</b>	
	<b>1</b>	<b>2123000.0</b>	<b>START</b>
	<b>2</b>	<b>3223000.0</b>	<b>2002-03-03</b>
	<b>3</b>	<b>5333000.0</b>	<b>12:34:56</b>
	<b>4</b>	<b>6443000.0</b>	
	<b>5</b>	<b>1552000.0</b>	<b>FINISH</b>
	<b>6</b>	<b>8663000.0</b>	<b>2002-05-05</b>
	<b>7</b>	<b>9773000.0</b>	<b>22:11:33</b>
<b>8</b>	<b>3893000.0</b>		
<b>ZERO</b>	<b>PRINT</b>	<b>DELETE</b>	<b>FIRST</b>
		<b>MENU</b>	

**DELELT** : It CAN delete all HISTOGRAM and HIGTOGRAM PER FORMULA

### 3-3-6. TIME SET SCREEN

This Screen is for SETTING Screen of DATA,TIME

As This TIME was set with A real TIME,

It does not set TIME separately after POWER ON.

(Fig 13 : TIME SET SCREEN)

F 01	B 04	74.2	Kg
<b>SET : DATE / TIME</b>			
<b>YY/MM/DD</b>			
NOW	DATE	970214	
NEW	DATE	970214	
<b>HH/MM/SS</b>			
NOW	TIME	150936	
NEW	TIME	000015	
Edit the Value,PRESS			
ZERO	*	*	FIRST    END

### 3-3-7. OPTION SETTING SCREEN

This Screen is for Interface Board Setting Screen.

It can set two Interface Channel with NO1 and NO2 by Cursor.

(Fig 14 : OPTION SET SCREEN)

<b>NO1</b>		<b>NO2</b>	
<b>BAUD RATE</b>	00	00	
<b>PARITY</b>	00	00	
0:9600 1:4800 2:2400 3:1200 4:600			
ZERO	*	*	FIRST    MENU

# CHAPTER 4. SYSTEM SETTING

## 4-1. SYSTEM SETTING FOR THE USER

This is for a general SYSTEM SETTING SCREEN which the user can

Please select SYSTEM SET1 After going to MANU SELECT by the NEXT key in the screen.

<Fig. 15> Menu Select screen 2

FORMULA 01		74.2	g
<b>MENU SELECT 2</b>			
1. CALIBRATION			
2. <b>SET UP</b>			
3. SYSTEM TEST			
Press Enter After Select			
ZERO	*	*	FIRST PRE

Initial screen

F5(MENU)

F5(NEXT)

2 or △ ▽ Enter

If you push a wrong button,  
The Error message will be displayed.



<Fig. 16> SET UP SYSTEM 1

<b>SET UP SYSTEM 1</b>			
F01 ( DECIMAL POINT )	01		
F02 ( SET UNIT )	00		
F03 ( PRINT AUTO/MANU )	01		
F04 ( WEIGHT BACK UP )	01		
F05 ( DICISION DELAY TIME )	20		
F06 ( SIGNAL DURATION TIME )	20		
F07 ( EMPTY WEIGHT )	5.0		
0 : 0    1 : 0.0    2 : 0.00    3 : 0.000			
*	*	FIRST.	PREV

#### 4-2-1. DECIMAL POINT (F1)

The decimal point can be set up to 3 digits as following procedure

Please select **SYSTEM SET 1** in **MENU SELECT** by **F5** Key Pushing  
Set the decimal point position by F01 in system setting mode.  
→ Move the cursor to F01 then help message will be displayed for the setting of decimal point position

**0 : 0    1 : 0.0    2 : 0.00    3 : 0.000**

#### 4-2-2. SET UNIT(F2)

The unit of g, kg, ton and lb can be set by F02 key in SYSTEM SET 1 SCREEN.

**0 : g    1 : kg    2 : ton    3 : lb**

#### 4-2-3. WEIGHT BACKUP(F3)

This Function is for keeping All setting Memory before POWER OFF

**0 : NO    1 : YES**

**\* If Selecting No 1(YES),It can re-worked after Re-POWER ON Despite of An electronic Spark during working**

#### 4-2-4. DECISION DELAY TIME(F4)

If it stop supplying Law Materials from TANK after closing 2<sup>nd</sup> STEP Gate,

Then,the Final Weight will be accumulated until the new BIN Signal will be sent.

So,SIGNAL DELAY TIME is until a previous BIN Signal will go to the next BIN Work.

In case of the last BIN,then BATCH FINISH Signal will be sent together.

And this TIME can be set with 0.1SEC/Unit.

**\* If DECISION DELAY TIME : 00, Then All BATCH will be worked by Steady Singal.**

#### 4-2-5. SIGNAL DURATION TIME(F5)

This is for TIME SETTING for **DURATION TIME** of BIN FINISH SIGNAL or BATCH FINISH SIGNAL And this TIME can be set with 0.1SEC/Unit.

**\* If SIGNAL DURATION TIME : 00, Then It keeps until START/STOP Signal will be sent**

#### 4-2-6. EMPTY WEIGHT SET(F6)

If Gross Weight on the weighing part was under EMPTY RANGE,

ZERO Signal and EMPTY Signal will be sent.

This means that Law Materials was completely discharged from the weighing part.

# CHAPTER 5. CALIBRATION

It means Calibration which is setting A digit and Max.Weight Capacity by Standard Test Weight For more precise Weight sensing.

**If you want to re-install FS-6100A or to re-set a correct weight value before,**  
Please set Calibrations as follows.

<Fig. 15> Menu Select Screen 2

FORMULA 01		74.2 g
<b>MENU SELECT 2</b>		
<ol style="list-style-type: none"> <li>1. CALIBRATION</li> <li>2. SYSTEM SET 1</li> <li>3. SYSTEM TEST</li> </ol>		
Pls Enter Key after selecting		
ZERO	*	*
FIRST	PRE	

Initial screen

F5(MENU)

F5(NEXT)

2 or △▽ Enter

If you push a wrong button,  
The Error message will be displayed.

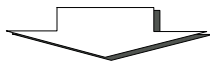

<b>CALIBRATION MODE</b>				
MINIUM DIGIT	=	<span style="border: 1px solid black; padding: 2px;">2</span>		
MAX CAPACITY	=			
BASE ZERO	=			
STANDARD WEIGHT	=			
SPAN CONSTANT	=			
*	*	*	*	END

◀ or ▶ (DIGIT SET)

A Digit can be set 1, 2, or 5  
by ◀▶ key.



◀ or Enter



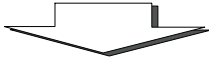

CALIBRATION				
DIGIT	=	2		
MAX. WEIGHT	=	300.0		
BASIC WEIGHT	=			
STANDARD WEIGHT	=			
SPAN CONSTANT	=			
*	*	*	*	END



CALIBRATION				
DIGIT	=	2		
MAX. WEIGHT	=	300.0		
BASIC WEIGHT	=	2947		
STANDARD WEIGHT	=			
SPAN CONSTANT	=			
				WAIT
*	*	*	*	END



3000 (Set of maximum weigh)



Max.Weight can be set Until 10000time x a digit  
We recommend it to set Around 3000~5000 Times.

▽ or Enter



BASIC Weight is Standard weight to judge Law  
Material Weight.  
We recommend it to set Around 12000.  
If pushing ▽ key,it automatically can be set

▽ or Enter



<b>CALIBRATION</b>				
DIGIT =		2		
MAX. WEIGHT =		300.0		
BASIC WEIGHT =		2947		
STANDARD WEIGHT =		300.0		
SPAN CONSTANT =				
<b>PLACE</b>				
*	*	*	*	END

**\* Standard Test Weight Input\***

The Standard Test weight must be used as Over 1/10 Weight of Max.Capacity

**\* Place Standard Test Weight \***

In case of using Standard Test Weight less than Max.Capacity Weight  
Please input this Value to Standard Weight.

In case of using Standard Test Weight like Max.Capacity Weight  
Please push  or  after Placing the Standard Test Weight like Max.Capacity Weight on the weighing Part.

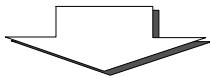

<b>CALIBRATION</b>				
DIGIT =		2		
MAX. WEIGHT =		300.0		
BASIC WEIGHT =		2947		
STANDARD WEIGHT =		300.0		
SPAN CONSTANT =		013327		
<b>REMOVE</b>				
*	*	*	*	END

or

It displays CALCULATING in the Screen.

Then after Calculating them,  
Please remove Standard Test Weight from the Weighing Part

or

CALIBRATION				
DIGIT	=	2		
MAX. WEIGHT	=	300.0		
BASIC WEIGHT	=	2947		
STANDARD WEIGHT	=	300.0		
SPAN CONSTANT	=	150423		
			OK	
*	*	*	*	END



**F5(End)**

- \* If you want to change any value in calibration mode, you can return to previous mode pressing by  $\Delta$  key.
- \* If you press **F5(End)** before Calibrating, All Calibration will be cancelled. Also it will be converted to the previous Screen.
- \* If you input any wrong value, It Display The Error message in The Screen.

## **\* Quick Operating Manuals \***

- (1) Pls check if Law Materials were discharged from the weighing part.**
- (2) Pls check FORMULA NO in running.**
- (3) Pls check if RUN Icon is running or not.**
- (4) Pls Push START KEY or START Signal.**
- (5) Pls start to run.**
- (6) Pls check if all work are being runed through a processing Screen.**
- (7) All system will be re-runned if any Error have no**